

# General Specifications

Link-Belt® 75-ton (68.03 metric ton)

## Wire rope truck crane

# HC-138A

GENERAL INFORMATION ONLY

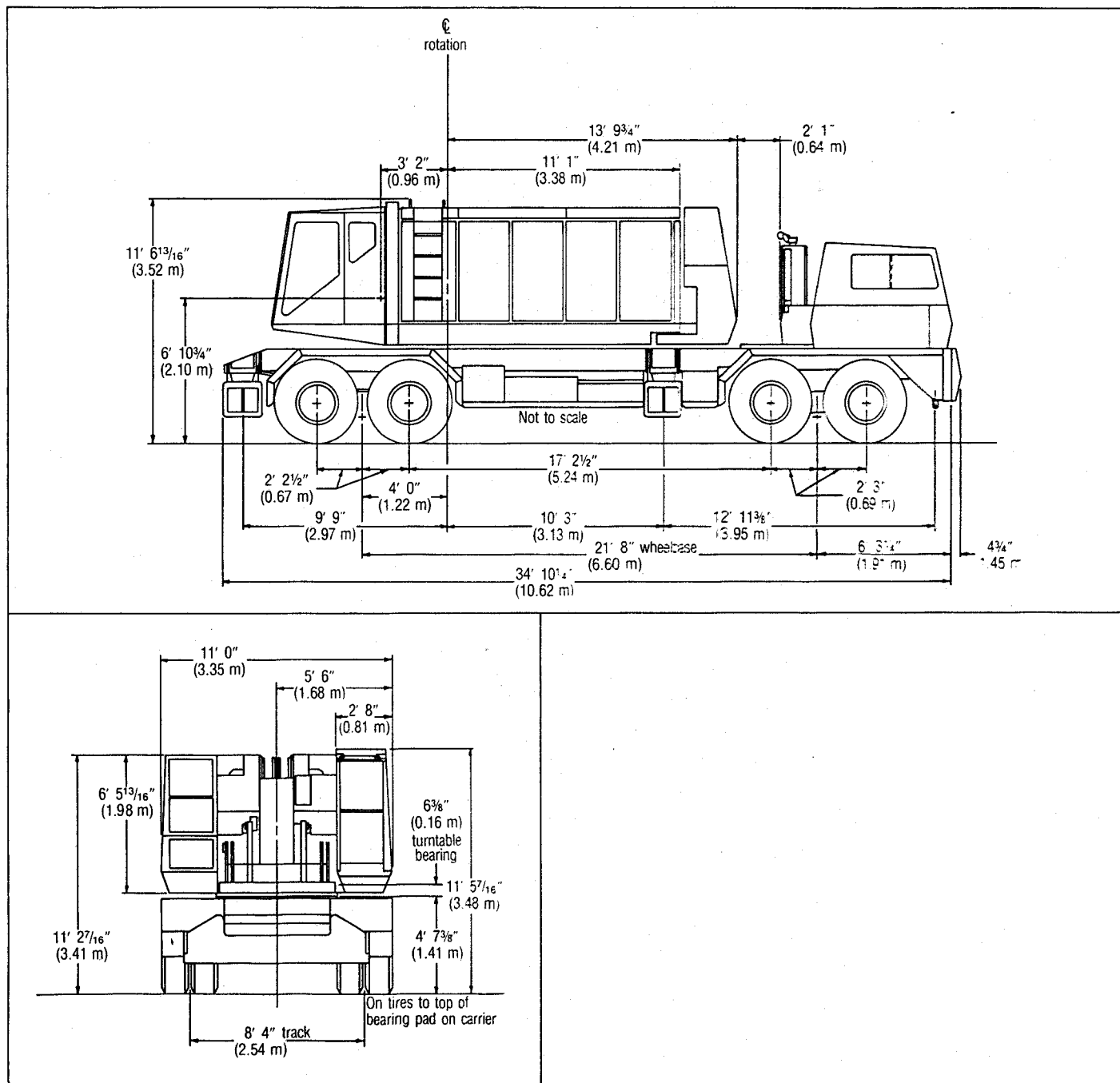

General dimensions	Feet	meters
Overall width, outriggers extended, (over floats)	22' 0"	6.71
Overall width, outriggers extended, (centerline of jacks)	19' 6"	5.94
Overall width, outriggers retracted, (floats removed)	11' 0"	3.35
Minimum ground clearance	12½"	0.32
Ground clearance under upper counterweight with machine on tires	56½"	1.44
Counterweight tailswing, across corners of counterweight	14' 10½"	4.54
Upper cab overall width	11' 0"	3.35
Basic boom length — open throat	40' 0"	12.19
— hammerhead	25' 0"	7.62
Radius of boomfoot pin	38"	0.97
Height of boomfoot pin	82¾"	2.10

General dimensions	Feet	meters
Overall length with basic length boom in travel position over rear of carrier with bumper counterweight — open throat boom	69' 2"	21.08
— hammerhead boom	53' 2¼"	16.21
Overall length with basic length boom in travel position over front of carrier — open throat boom	53' 6"	16.31
— hammerhead boom	42' 6"	12.95
Height over boom live mast with basic length boom in travel position over rear of carrier	—	—
— open throat boom	12' 4"	3.76
— hammerhead boom	11' 5"	3.48
Height over boom live mast with basic length boom in travel position over front of carrier	—	—
— open throat boom	13' 4"	4.06
— hammerhead boom	13' 4"	4.06

## GENERAL INFORMATION ONLY

### Axle loadings — approximate

Based on HC-138A crane upper equipped with 18,000 lb. (8 165 kg) counterweight "A", boom lowering planetary, rear drum hoisting and lowering clutches, GM 6-71N with single stage torque converter mounted on FMC 8x4, 11' 0" (3.35 m) wide, 260" (6.60 m) wheelbase carrier with GM 6V-92TA diesel, 14:00x24 J (18-ply rating) Goodyear Hi-Miler tires, hydraulic outriggers front and rear, 4 floats in storage racks, front center hydraulic jack and float, and 1,500 lb. (608 kg) front bumper counterweight.	Basic machine gross weight		Upper facing front				Upper facing rear				
	**	Lbs.	kg	Front		Rear		Front		Rear	
		Lbs.	kg	Lbs.	kg	Lbs.	kg	Lbs.	kg	Lbs.	kg
A	48,850	22 158	6,770	3 071	55,620	25 229	24,810	11 254	24,040	10 905	
B	46,580	21 129	21,420	9 716	25,160	11 413	21,420	9 716	25,160	11 413	
C	95,430	43 287	14,650	6 645	80,780	36 642	46,230	20 970	49,200	22 317	
Adjust axle loadings accordingly for the following components:	Component weights		Front		Rear		Front		Rear		
	Lbs.	kg	Lbs.	kg	Lbs.	kg	Lbs.	kg	Lbs.	kg	
<b>Upper machinery —</b>											
Boom lowering clutch (two-speed)	+ 350	+ 159	- 30	- 14	+ 380	+ 173	+ 150	+ 68	+ 200	+ 91	
Boomhoist raising planetary	+ 450	+ 204	- 40	- 18	+ 490	+ 222	+ 200	+ 91	+ 250	+ 113	
Boomhoist wire rope — 495' (150.88 m), ¾" (19 mm) diameter, Type "T":											
— On drum	+ 520	+ 236	- 40	- 18	+ 560	+ 254	+ 230	+ 104	+ 290	+ 132	
— For 23' 0" (7.01 m) mast in horizontal position	+ 520	+ 236	+ 320	+ 145	+ 200	+ 91	- 120	- 54	+ 640	+ 290	
Front drum load lowering clutch	+ 350	+ 159	+ 50	+ 23	+ 300	+ 136	+ 80	+ 36	+ 270	+ 123	
Front drum planetary — load hoist	+ 450	+ 204	+ 60	+ 27	+ 390	+ 177	+ 110	+ 55	+ 340	+ 154	
Front drum planetary — load lowering	+ 450	+ 204	+ 60	+ 27	+ 390	+ 177	+ 110	+ 50	+ 340	+ 154	
Front drum wire rope — 1,000' (304.80 m), ¾" (19 mm) diameter, Type "N"	+ 1,040	+ 472	+ 140	+ 63	+ 900	+ 409	+ 250	+ 113	+ 790	+ 359	
Rear drum planetary — load hoist	+ 450	+ 204	0	0	+ 450	+ 204	+ 160	+ 73	+ 290	+ 131	
Rear drum planetary — load lowering	+ 450	+ 204	0	0	+ 450	+ 204	+ 160	+ 73	+ 290	+ 131	
Rear drum wire rope — 1,000' (304.80 m), ¾" (19 mm) diameter, Type "N"	+ 1,040	+ 472	+ 10	+ 5	+ 1,030	+ 467	+ 370	+ 168	+ 670	+ 304	
Third drum with front drum lowering clutch and gear to power third drum	+ 1,750	+ 794	+ 400	+ 181	+ 1,350	+ 613	+ 250	+ 113	+ 1,500	+ 681	
Third drum load lowering clutch	+ 350	+ 159	+ 80	+ 36	+ 270	+ 123	+ 50	+ 23	+ 300	+ 136	
Third drum wire rope — 370' (112.78 m), ¾" (19 mm) diameter, Type "N"	+ 380	+ 172	+ 90	+ 41	+ 290	+ 131	+ 50	+ 22	+ 330	+ 150	
Upper counterweight "A"	- 18,000	- 8 165	+ 7,220	+ 3 275	- 25,220	- 11 440	- 13,870	- 6 291	- 4,130	- 1 874	
Upper counterweight "B"	+ 12,000	+ 5 443	- 4,810	- 2 182	+ 16,810	+ 7 625	+ 9,240	+ 4 191	+ 2,760	+ 1 252	
Optional Cummins N855-C220 diesel with 3-stage torque converter	+ 1,760	+ 798	- 430	- 195	+ 2,190	+ 993	+ 1,080	+ 490	+ 680	+ 308	
<b>Crane booms and auxiliary equipment —</b>											
40' (12.19 m) basic open throat boom with accessories	+ 3,980	+ 1 805	+ 6,020	+ 2 730	- 2,040	- 925	- 4,550	- 2 064	+ 8,530	+ 3 869	
20' (6.10 m) open throat boom top section only	- 2,350	- 1 066	- 4,600	- 2 087	+ 2,250	+ 1 021	+ 3,730	+ 1 692	- 6,090	- 2 758	
25' (7.62 m) basic hammerhead boom with accessories	+ 4,160	+ 1 887	+ 4,880	+ 2 214	- 720	- 327	- 3,340	- 1 515	+ 7,500	+ 3 402	
5' (1.52 m) hammerhead boom top section only	- 2,530	- 1 148	- 3,460	- 1 569	+ 930	+ 421	+ 2,530	+ 1 148	- 5,060	- 2 296	
Boom stops	+ 700	+ 318	+ 250	+ 113	+ 450	+ 205	+ 10	+ 5	+ 690	+ 313	
Boom live mast (extended and horizontal), bridle and spreader bar	+ 3,370	+ 1 529	+ 3,440	+ 1 560	- 70	- 31	- 2,190	- 993	+ 5,560	+ 2 522	
<b>Carrier —</b>											
Front outrigger box, beams and jacks	- 5,200	- 2 359	- 3,420	- 1 552	- 1,780	- 807	- 3,420	- 1 552	- 1,780	- 807	
Rear outrigger box, beams and jacks	- 5,200	- 2 359	+ 1,380	+ 626	- 6,580	- 2 985	+ 1,380	+ 626	- 6,580	- 2 985	
Front and rear outrigger floats (4)	- 500	- 227	- 140	- 64	- 360	- 163	- 140	- 64	- 360	- 163	
Front center hydraulic jack	- 130	- 59	- 170	- 77	+ 40	+ 18	- 170	- 77	+ 40	+ 18	
Front center hydraulic jack float (1)	- 130	- 59	- 60	- 27	- 70	- 32	- 60	- 27	- 70	- 32	
Bumper counterweight "A"	- 1,500	- 680	- 1,940	- 880	+ 440	+ 200	- 1,940	- 880	+ 440	+ 200	
Optional Cummins NTC-290 diesel	+ 740	+ 336	+ 800	+ 363	- 60	- 27	+ 800	+ 363	- 60	- 27	
Optional 14:00x20J All service Goodyear	0	0	0	0	0	0	0	0	0	0	
Optional 14:00x20J SRL-1 Goodyear	+ 630	+ 286	+ 210	+ 95	+ 420	+ 191	+ 210	+ 95	+ 420	+ 191	
Optional 14:00x20J HCT General	+ 330	+ 150	+ 110	+ 50	+ 220	+ 100	+ 110	+ 50	+ 220	+ 100	
Optional 14:00x20J Goodrich	+ 480	+ 218	+ 160	+ 73	+ 320	+ 145	+ 160	+ 73	+ 320	+ 145	

\*\*A — upper; B — carrier; C — total weight of upper and carrier.

Ⓞ Optional GM 6-71 with three stage torque converter is equivalent in weight to GM 6-71 single stage torque converter.

## General specifications

### Carrier

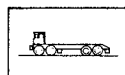

#### Type

FMC; 8 x 4 drive, 260" (6.60 m) wheelbase, 11' 0" (3.35 m) wide.

**Frame** — Main members heat treated alloy steel; machined surface for mounting turntable bearing. Formed channel front bumper.

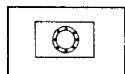

#### Turntable bearing

Outer race, with integral swing (ring) gear bolted to carrier.

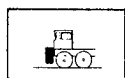

#### Bumper counterweight

Easily removed, mounts on front bumper hooks. Refer to lifting capacity charts for counterweight requirements.

*Bumper counterweight "A"* — 1,500 lbs. (680 kg).



#### Front axles

Shuler FTKC-34L; bogie beam mounted tandem axles, single wheels. Track — 110¼" (2.80 m).

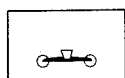

#### Bogie

Hendrickson; rubber bushed equalizer beams and torque rods.

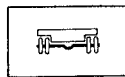

#### Rear axles

Clark Planetary BD-57000, bogie mounted tandem axles, dual wheels. Track — 100" (2.54 m).



#### Bogie

Hendrickson; bronze bushed equalizer beams, rubber bushed torque rods.

**Tag axle** — Optional; Transport Trailer, equipped with air brakes, 10:00 x 20F (12-ply rating) dual tires.

**Wheels and rims** — Front; cast spoke type. Rear; integral with planetary hubs.



#### Tires

Single tires front; dual tires rear.

*Standard* — 14:00 x 20J (18-ply rating) Goodyear Custom Hi-Miler.

*Optional* — 14:00 x 20J (18-ply rating) All service Goodyear; 14:00 x 20J (18-ply rating) SRL-1 Goodyear; 14:00 x 20J (18-ply rating) HCT General; 14:00 x 20J (18-ply rating) Goodrich.

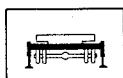

#### Outriggers

Full width, double box, front and rear; pin connected to carrier frame. Hydraulically operated beam and jack cylinders individually controlled from each side of carrier. Hydraulic power supplied by PTO-driven hydraulic pump. Check valve at each jack cylinder.

*Optional* — Outrigger beam and jack cylinder controls in crane upper cab.

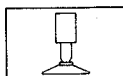

#### Front center hydraulic jack with float

Required for handling 360° swing rated capacities. Warning horn sounds if ground surface allows front outriggers to settle.

*Floats* — Low profile, alloy steel lightweight; 30" (0.76 m) square base.

**Trailer hitch** — *Optional*; includes air and electric connections at rear of carrier for trailer lights and air brakes.

**Brakes** — 8-wheel air brakes.

*Service* — Single diaphragm air chambers on four front wheels; Maxi brakes on four rear wheels.

*Size and area* — Rear wheels; 16½" x 7" (0.42 x 0.18 m); total effective lining area, 455 square inches (2 936 cm<sup>2</sup>) per axle. Front wheels; 17-¼" x 4" (0.44 x 0.10 m); total effective lining area, 248 square inches (1 600 cm<sup>2</sup>) per axle.

*Parking* — Brakes on four rear wheels spring applied; air control valve on dash.

*Emergency* — Air brakes on four rear wheels spring apply automatically if air pressure drops to 45 p.s.i. (310.28 kPa) in system. Emergency brake may be manually applied any time by hand control of dash-mounted air control valve.

## GENERAL INFORMATION ONLY



#### Steering

Power hydraulic assist. Ross HPS 70 steering gear; 18" (0.46 m) diameter steering wheel.

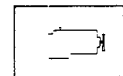

#### Engines

Diesel; 12-volt starter, pressure lubrication, hydraulic pump, dry type air cleaner, and 14.5 c.f.m. (0.41 m<sup>3</sup>/min) air compressor.

*Standard* — GM 6V-92TA diesel. 6 cylinder. 2 cycle. 4.84" (0.12 m) bore, 5" (0.13 m) stroke. 552 cu. in. (9 047 cm<sup>3</sup>) displacement, 318 brake horsepower (237 133 W) at 2,100 r.p.m. governed load speed. Peak torque 914 ft. lbs. (1 239 J) at 1,400 r.p.m. Pushbutton electric shutdown. 12-volt, 65 amp alternator.

*Optional* — Cummins NTC-290 diesel. 6 cylinder, 4 cycle, 5-½" (0.14 m) bore, 6" (0.15 m) stroke, 855 cu. in. 14 013 cm<sup>3</sup> displacement, 290 brake horsepower (216 253 W) at 2,100 r.p.m. governed load speed. Peak torque 930 ft. lbs. (1 261 J) at 1,300 r.p.m. Electric shutdown. 12-volt, 75 amp alternator.

**Clutch** — Lipe-Rollway. 14" (0.36 m), 2-plate, dry disc.

#### Transmissions

*Main* — Fuller RTO-915; 15 speeds forward, 3 reverse.

*Auxiliary* — Fuller AT-1202; 2-speed, midship mounting (for creeping only).

**Universals** — Rockwell Standard or Mechanics type drive tubes; needle bearings.

**Cab** — One-man, offset, fully enclosed. Rubber suspension mounted bucket seat with seat belt. Noise absorbing insulation with vinyl covering, sound reduction headliner, carpet floor mat; isolated from engine compartment. rubber mounted for sound level reduction. Instrument panel and dash includes speedometer, odometer, voltmeter, and gauges for fuel, engine temperature, air and oil pressures. Low air pressure warning buzzer, key locking switch, pushbutton starter, throttle control, tachometer, heater and defroster, 2-speed electric windshield wiper, windshield washer, and dry type fire extinguisher.

# GENERAL INFORMATION ONLY

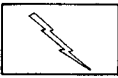

## Electrical system

12-volt; including dual sealed beam headlights, directional signals with 4-way flashing system, stop and tail lights, clearance lights, horn, lighting of instrument panel, dome light, headlight dimmer switch, and two 12-volt, 225 ampere hour batteries. Individual switches provide circuit control for hydraulic outrigger solenoid valves; one control station on each side of carrier.

**Standard auxiliary equipment** — West Coast rear view mirrors, boom guide, lug wrench, 2-way reading bubble levels at four positions on carrier frame, tire gauge and tire inflation hose. High pressure lube fittings at all bearing points, hand grab rails, carrier deck access ladder, back-up alarm, skid-resistant finish on carrier deck, fenders, and mud flaps.



## Fuel tanks

Two 45-gallon (170.31 liter) capacity fuel tanks mounted under carrier with filler spout on each side of carrier.

## Carrier speeds

Based on GM 6V-92TA or Cummins NTC-290 engines running at 2,100 r.p.m. governed full load speed.						
Gear		Main-Fuller RTO-915	Auxiliary — Fuller AT-1202			
			1.00:1.00		2.036:1.00	
			M.p.h.	km/h	M.p.h.	km/h
High	10th	0.81	40.2	64.68	19.8	31.82
	9th	1.00	32.6	52.45	16.0	25.74
	8th	1.26	25.9	41.67	12.7	20.43
	7th	1.59	20.5	32.98	10.1	16.25
	6th	2.04	13.6	21.88	6.7	10.78
	Reverse	2.21	14.7	23.66	7.2	11.58
Low	5th	2.59	12.6	20.27	6.2	9.98
	4th	3.20	10.2	16.41	5.0	8.05
	3rd	4.04	8.1	13.03	4.0	6.44
	2nd	5.10	6.4	10.30	3.1	4.99
	1st	6.51	5.0	8.05	2.5	4.02
	Reverse	7.06	4.6	7.40	2.3	3.70
Deep reduction	5th	3.87	8.4	13.52	4.1	6.60
	4th	4.78	6.8	10.94	3.3	5.31
	3rd	6.03	5.4	8.69	2.7	4.34
	2nd	7.62	4.3	6.92	2.1	3.38
	1st	9.73	3.4	5.47	1.6	2.57
	Reverse	10.55	3.1	4.99	1.5	2.41

Creep speed in deep reduction low (1st), based on GM 6V-92TA peak torque r.p.m. — (1,400) 1.1 m.p.h. (1.77 km/h); based on Cummins NTC-290 peak torque r.p.m. (1,300) — 1.0 m.p.h. (1.61 km/h). Note: Rear axle ratio — 8.67 to 1.0.

## Turning ability

Turning circle diameter	Curb clearance circle diameter	Vehicle clearance circle diameter	
		Over outside of front bumper	Over outside of front bumper counterweight "A"
Centerline of outer front tire	Outside of outer front tire		
120' 3" (36.66 m)	122' 0" (37.19 m)	126' 0" (38.40 m)	126' 5" (38.53 m)

## Revolving upperstructure



**Frame**

All welded, stress relieved, precision machined; machinery side housings welded integral with frame.

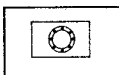

**Turntable bearing**

Inner race of bearing bolted to machined surface on under side of frame.

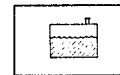

**Fuel tank**

75-gallon (284 liter) capacity fuel tank equipped with fuel gauge and fill pipe with flame arrester unit.

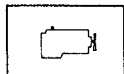

**Engines**

Diesel; full pressure lubrication, oil filter, air cleaner, hour meter, foot and optional hand throttles. Manual control shutdown for GM engine, electrical shutdown for Cummins engine.

## GENERAL INFORMATION ONLY

Engine specifications	GM 6-71N with single stage torque converter <sup>①</sup>	GM 6-71N with three stage torque converter <sup>①</sup>	Cummins N855-C220 with three stage torque converter <sup>②</sup>
Number cylinders	6	6	6
Bore and stroke	4¼" x 5" (0.11 x 0.13 m)	4¼" x 5" (0.11 x 0.13 m)	5½" x 6" (0.14 x 0.15 m)
Piston displacement (cu. in.)	425.6 (6 976 cm <sup>3</sup> )	425.6 (6 976 cm <sup>3</sup> )	855 (14 013 cm <sup>3</sup> )
High idle speed r.p.m.	1,950	1,940	1,980
Engine r.p.m. at full load speed	1,800	1,800	1,800
Net engine horsepower at full load speed	165 (123 041 W)	165 (123 041 W)	137 (102 161 W)
Peak torque (foot pounds)	1,400 (1 898 J)	2,360 (3 200 J)	1,898 (2 574 J)
Peak torque r.p.m.	Output shaft stall	Output shaft stall	Output shaft stall
Electrical system	12-volt	12-volt	12-volt
Batteries	One/12-volt	One/12-volt	Two/12-volt
Clutch or power take-off	Disconnect between engine and converter	Disconnect between engine and converter	Disconnect between engine and converter
Transmission —	—	—	—
Number chain wheel teeth	161	161	161
Number engine pinion teeth	21	28	28

<sup>①</sup>Allison #TCDO 475 torque converter.

<sup>②</sup>Twin Disc #CO-10066 T.C. torque converter.

## Power train

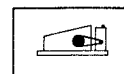

**Transmission**

Triple roller chain enclosed in oil tight chain case with integral lubrication system.

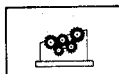

**Machinery gear train**

"Full Function" design, two-directional power available to all operating shafts; shafts mounted on anti-friction bearings in precision bored machinery side housings. All load hoist, swing, and boomhoist functions independent of one another. Components such as gears, pinions, chain wheels, brake drums and clutch spiders involute splined to shafts. Drum gear/clutch drum assemblies bolted together and mounted on shafts on anti-friction bearings. Machine-cut teeth on drum gears, pinions, spur gears, and chain wheel. Chain wheel and pinion fully enclosed and running in oil.

## Principal operating functions



### Control system

Speed-o-Matic® power hydraulic control system; a variable pressure system requiring no bleeding. Operating pressure transmitted to all 2-shoe clutch cylinders, and other hydraulic cylinders as required. System includes constant displacement, engine driven, vane type hydraulic pump to provide flow of oil; accumulator to maintain system operating pressure, unloader valve to control pressure in accumulator, relief valve to limit maximum pressure buildup in system, full-flow filter with 40 micron disposable filter element, and variable pressure control valves to control drum clutches and other operating cylinders.

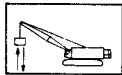

### Load hoisting and lowering

Wire rope drum gear train (front and rear main, and optional third, operating drums) powered by chain transmission from engine.

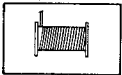

### Load hoist drums

**Front and rear main operating drums** – One-piece, 14" (0.36 m) root diameter smooth drums; involute splined to shafts. Extended length shafts permit installation of power load lowering clutches; special length shaft required for, and furnished with, optional planetary drive units for either or both drums.

**Third operating drums** – Optional; mounts forward of front main operating drum. One-piece, 10½" (0.27 m) root diameter smooth drum; involute splined to shaft. **Note:** Installation of optional third operating drum includes required installation of power load lowering clutch/gear unit on front main operating drum shaft.



### Drum clutches

Speed-o-Matic® power hydraulic 2-shoe clutches. Internal expanding, lined aluminum alloy shoes; clutch spiders splined to shafts, clutch drums bolted to drum spur gears and mounted on shafts on anti-friction bearings. Front, rear, and optional third, main operating drum clutches, swing clutches, and boom hoist clutch are fully interchangeable.

**Load hoist clutches** – Front and rear main, and optional third, operating drums — 18" (0.46 m) diameter, 4½" (0.11 m) face width.

**Load lowering clutches** – Standard on rear main drum; optional on front main, and optional third, operating drums. Clutches 18" (0.46 m) diameter, 4½" (0.11 m) face width.

**Drum planetary drive units** — *Optional*; available for load hoist or lowering on either or both front and rear main operating drums. Planetary units mount on extended drum shafts between drum spur gears and 2-shoe clutch drums. Available for **either** increase **or** decrease of standard load hoist or lowering line speeds — choice of increased or decreased line speeds predetermined by customer at time of order. Two-shoe clutches control standard line speeds. Planetary drive units controlled by external contracting band brakes through push button located on appropriate control lever.



### Drum brakes

Two-piece, external contracting band; mechanically foot pedal operated. Foot pedals equipped with latch to permit locking brakes in applied position.

**Front and rear main drums** – Brakes 32" (0.81 m) diameter, 4" (101.60 mm) face width.

**Optional third drum** – Brake 26" (0.66 m) diameter, 4" (101.60 mm) face width.

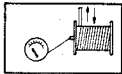

### Drum rotation indicators

Standard for front and rear main operating drums. Two electrically operated indicator buttons, recessed in drum clutch control lever handles; one button pulsates when rope drums rotate in one direction, the other button pulsates when drums rotate in opposite direction. Operator can adjust pulsations to determine either rope speed off drum or hook block speed based on specific number of parts of load hoist rope.

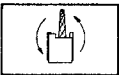

### Swing system

Spur gear driven; single bevel gears (enclosed and running in oil) on horizontal and vertical swing shafts. Swing pinion, involute splined to vertical swing shaft, meshes with external teeth of swing gear integral with outer race of turntable bearing.



### Swing clutches

18" (0.46 m) diameter, 4½" (0.11 m) face width; lined, aluminum alloy shoes.

**Swing brake** – External contracting band; spring applied, hydraulically released by operator controlled lever. Brake drum involute splined to vertical swing shaft; brake 18" (0.46 m) diameter, 3" (76.20 mm) face width.

**Swing lock** – Mechanically controlled pawl engages external teeth of turntable bearing swing (ring) gear.

*Maximum swing speed* – 3.4 r.p.m.



### Boom hoist/lowering system

Independent, spur gear driven. Precision control — hoisting through power hydraulic 2-shoe clutch; lowering through low speed planetary drive unit.

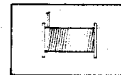

### Boomhoist drum

10½" (0.27 m) root diameter, smooth; involute splined to shaft.

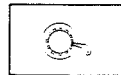

### Boomhoist drum locking pawl

Operator controlled; spring applied, mechanically released.



### Boom hoist clutch

18" (0.46 m) diameter, 4½" (0.11 m) face width.



### Boom lowering clutch

*Optional*; in addition to planetary boom lowering. Two-shoe clutch permits higher speed boom lowering mounted on shaft outside planetary unit, clutch drum bolted to outer face of planetary housing. Clutch power hydraulically controlled by depressing solenoid push button located on boom hoist/lowering control lever.

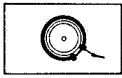

**Boom hoist/lowering brake**

External contracting band; spring applied, hydraulically released as hoist clutch or lowering planetary are engaged. Brake drum involute splined to shaft; brake 26" (0.66 m) diameter, 4" (101.60 mm) face width.

**Boom hoist limiting device** – Provided to restrict hoisting boom beyond recommended minimum radius; located on exterior right-hand side of operator's cab.



**Electrical system —**

Battery, 12-volt, 225 ampere hour, either one or two batteries depending on engine. *Optional* – battery lighting system, including two sealed beam automotive type adjustable headlights located on cab front roof, one interior cab light and automotive type wiring. *Optional* – additional 50 watt sealed beam automotive type headlight mounted on boom. (Three maximum quantity recommended.) *Optional* – Onan independent light plant with single cylinder four cycle, air cooled diesel engine with remote electric starting, 3,000 watt, 120-volt, single-phase, 60 cycles A.C. including wiring in conduit, three interior cablights, trouble lamp with cord and two 300 watt adjustable flood lights on cab front roof. *Optional* – additional 300 watt floodlights available for mounting on cab and boom.

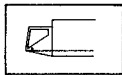

**Operator's cab**

Environmental cab, modular type isolated from upper machinery cab. Tinted tempered glass panels in all windows, hand grab rail, adjustable, cushioned seat with head rest, arm rests on control consoles, dry chemical fire extinguisher. Cab heater/defroster and windshield wiper *optional*.

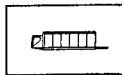

**Machinery cab**

Equipped with warning horn, hinged doors on two sides, rear, and top. Removable panels for machinery access, roof-top access ladder, and skid resistant finish on roof.

**Gantry** — Low type, mounted at top rear of machinery side housings; supports boom suspension system.

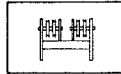

**Gantry bail**

Contains six 12" (0.30 m) root diameter sheaves, mounted on anti-friction bearings, for 14-part boomhoist wire rope reeving.

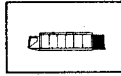

**Counterweight**

"A" counterweight — 18,000 lbs. (8 165 kg); "B" counterweight — 12,000 lbs. (5 443 kg). (Refer to counterweight requirement instructions with lifting capacity chart.)

## Booms and jibs

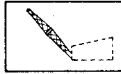

**Boom**

Tubular; two-piece basic boom 40' (12.19 m) long with open throat top section, 25' (7.62 m) long with hammerhead top section. Boom 54" (1.37 m) wide, 44" (1.12 m) deep at centerline of connections. Alloy steel, round tubular chords 3" (76.20 mm) outside diameter.

**Base section** – 20' (6.10 m) long. Boom feet 2 $\frac{3}{8}$ " (60.33 mm) thick on 54" (1.37 m) centers. Lifting lugs on top side of base section to facilitate attaching carrying links for carrying base section or for boom assembly.

**Boom extensions** – Available in 5' (1.52 m), 10' (3.05 m), 15' (4.57 m) 20' (6.10 m) and 30' (9.14 m) lengths. Extended hub on female connections serves as anchor for link used to attach jib staylines, boom suspension pendants for boom assembly, and boom midpoint suspension pendants.

**Boom folding section** – 10' (3.05 m) long; equipped with lifting hubs to accommodate boom folding shaft and two deflector rollers.

**Boom connections** – In-line, tapered pins.

**Boom top section** – Open throat; 20' (6.10 m) long.

**–Boompoint machinery.** Five 18" (0.46 m) root diameter head sheaves mounted on anti-friction bearings.

**Boom top section** – Hammerhead; 5' (1.52 m) long.

**–Boompoint machinery.** Five 18 $\frac{1}{2}$ " (0.47 m) root diameter head sheaves, plus one or two (optional) idler sheaves to guide load hoist wire rope onto head sheaves.

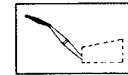

**Jib**

Tubular; basic two-piece 20' (6.10 m) long; 30" (0.76 m) wide, 24" (0.61 m) deep at connections. Alloy steel tubular chords 1 $\frac{1}{2}$ " (38.10 mm) outside diameter.

**Base section** – 10' 0" (3.05 m) long.

**Jib extensions** – Available in 10' (3.05 m) lengths with appropriate length pendants. Maximum boom/jib lengths permitted: open throat boom — 190' (57.91 m) boom plus 50' (15.24 m) jib; hammerhead boom — 180' (54.86 m) boom plus 50' (15.24 m) jib.

**Jib connections** – In-line, tapered pins.

**Tip section** – 10' 0" (3.05 m) long; single peak sheave 1 $\frac{1}{4}$ " (0.39 m) root diameter. mounted on anti-friction bearings.



**Jib mast**

10' 0" (3.05 m) high, mounted on jib base section. Two deflector sheaves mounted within mast to guide whipline; mounted on anti-friction bearings. Two equalizer sheaves mounted on top of mast — one for jib frontstay line, one for jib backstay line.

— **Jib staylines** – Front and rear staylines vary in length depending on degree of jib offset from boom centerline; backstay lines attached at bottom end of boom top section on open throat boom, and at a point 20' (6.10 m) below peak of hammerhead top section.

— **Jib stops** – Telescoping type; pinned from jib mast to boom top section and from jib mast to jib base section.